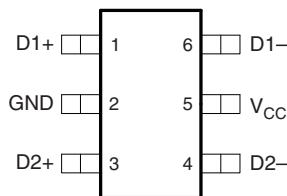
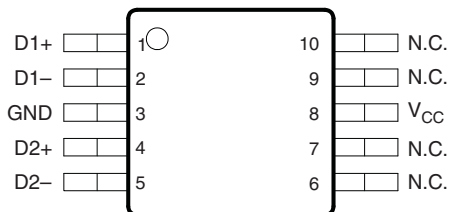
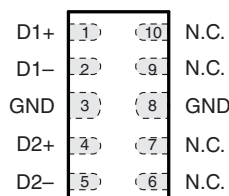
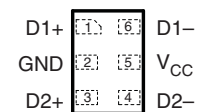

4-CHANNEL ESD SOLUTION FOR HIGH-SPEED DIFFERENTIAL INTERFACE

FEATURES

- Supports High-Speed Differential Data Rates (3-dB Bandwidth > 4 GHz)
- 0.05-pF Matching Capacitance Between Differential Signal Pairs
- Low 0.8-pF Line Capacitance for Each Data Line to GND
- Flow-Through Single-in-Line Pin Mapping for High-Speed Lines Ensures No Additional Board Layout Burden While Placing ESD Protection Chip Near Connector
- IEC 61000-4-2 (Level 4) System-Level ESD Compliance
- 2.5-A Peak Pulse Current (8/20- μ s Pulse)
- I_{off} Feature
- Industrial Temperature Range: -40°C to 85°C
- Space-Saving Package Options

TPD4S009...DBV OR DCK PACKAGE
(TOP VIEW)

TPD4S009...DGS PACKAGE
(TOP VIEW)

TPD4S010...DQA PACKAGE
(TOP VIEW)

TPD4S009...DRY PACKAGE
(TOP VIEW)

DESCRIPTION/ORDERING INFORMATION

TPD4S009/TPD4S010 provide an electrostatic discharge (ESD) solution for high-speed differential lines. This device offers four ESD clamp circuits for dual differential lines. The monolithic silicon technology allows matching between the differential signal pairs. The excellent matching between the differential pair signal lines (0.05-pF line-line) enables this device to operate at high-speed differential data rates (3-dB bandwidth > 4 GHz). TPD4S009/TPD4S010 are suitable for high-speed differential applications, such as high-definition multimedia interface (HDMI), low-voltage differential signaling (LVDS), serial advanced technology attachment (SATA), Ethernet, 1394 (FireWire[®]), etc.

TPD4S009/TPD4S010 comply with IEC 61000-4-2 (Level 4) ESD. TPD4S009 is offered in space-saving DBV, DCK, DGS, and DRY packages. TPD4S010 is offered in a DQA package.

TPD4S009/TPD4S010 are characterized for operation over the ambient air temperature range of -40°C to 85°C .



Please be aware that an important notice concerning availability, standard warranty, and use in critical applications of Texas Instruments semiconductor products and disclaimers thereto appears at the end of this data sheet.

FireWire is a registered trademark of Apple Inc.

ORDERING INFORMATION

T _A	PACKAGE ⁽¹⁾⁽²⁾		NOMINAL DIMENSIONS (mm)	ORDERABLE PART NUMBER	TOP-SIDE MARKING ⁽³⁾
–40°C to 85°C	MSOP – DGS	Reel of 3000	W = 4.9, L = 3, H < 1.1, Pitch = 0.5	TPD4S009DGSR	PREVIEW
	SON – DQA	Reel of 3000	W = 1, L = 2.5, H < 1.1, Pitch = 0.5	TPD4S010DQAR	PREVIEW
	SON – DRY	Reel of 5000	W = 1, L = 1.45, H = 0.55, Pitch = 0.5	TPD4S009DRYR	3H
	SOT (SC-70) – DCK	Reel of 3000	W = 2.1, L = 2, H = 0.95, Pitch = 0.65	TPD4S009DCKR	3H_
	SOT (SOT-23) – DBV	Reel of 3000	W = 2.9, L = 2.8, H < 1.45, Pitch = 0.95	TPD4S009DBVR	NFJK

- (1) Package drawings, thermal data, and symbolization are available at www.ti.com/packaging.
- (2) For the most current package and ordering information, see the Package Option Addendum at the end of this document, or see the TI website at www.ti.com.
- (3) DCK: The actual top-side marking has one additional character that designates assembly/test site.

CIRCUIT DIAGRAM

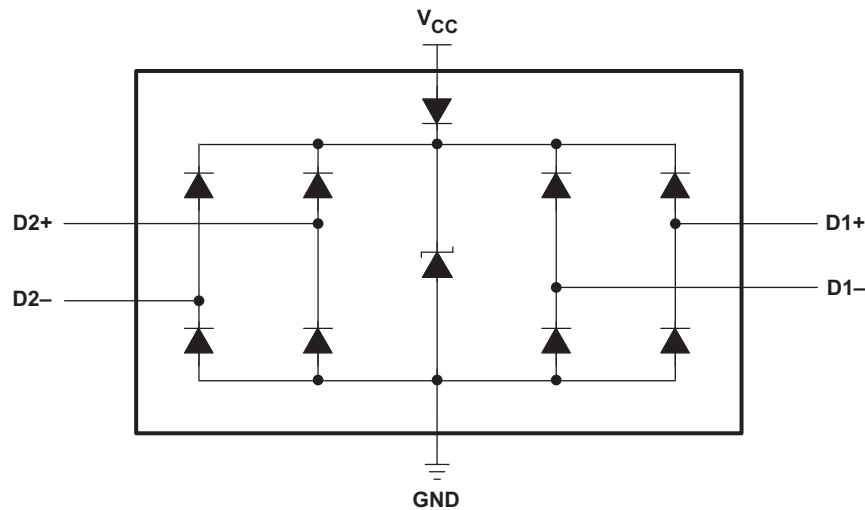

TERMINAL FUNCTIONS

DBV, DCK, OR DRY PIN NO.	DGS PIN NO.	DQA PIN NO.	NAME	I/O	DESCRIPTION
1, 3, 4, 6	1, 2, 4, 5	1, 2, 4, 5	D1+, D1–, D2+, D2–	ESD port	High-speed ESD clamp provides ESD protection to the high-speed differential data lines.
2	3	3, 8	GND	GND	Ground
–	6, 7, 9, 10	6, 7, 9, 10	N.C.	–	Not internally connected
5	8	–	V _{CC}	Pwr	Supply

ABSOLUTE MAXIMUM RATINGS

over operating free-air temperature range (unless otherwise noted)

		MIN	MAX	UNIT
V_{CC}	Supply voltage range	–0.3	6	V
V_{IO}	IO signal voltage range	0	V_{CC}	V
T_{stg}	Storage temperature range	–65	125	°C
T_A	Characterized free-air operating temperature range	–40	85	°C
	Lead temperature, 1.6 mm (1/16 in) from case for 10 s		260	°C
	IEC 61000-4-2 Contact Discharge		±8	kV
	IEC 61000-4-2 Air-Gap Discharge		±9	kV
	Peak pulse power ($t_p = 8/20 \mu s$)		25	W
	Peak pulse current ($t_p = 8/20 \mu s$)		2.5	A

ELECTRICAL CHARACTERISTICS

over operating free-air temperature range (unless otherwise noted)

PARAMETER	TEST CONDITIONS		MIN	TYP	MAX	UNIT		
V_{RWM}	Reverse standoff voltage	Any IO pin to ground			5.5	V		
V_{BR}	Breakdown voltage	$I_{IO} = 1 \text{ mA}$	Any IO pin to ground		9	V		
I_{IO}	IO port current	$V_{IO} = 3.3 \text{ V}, V_{CC} = 5 \text{ V}$	Any IO pin		0.01	0.1	μA	
I_{off}	Current from IO port to supply pins	$V_{IO} = 3.3 \text{ V}, V_{CC} = 5 \text{ V}$	Any IO pin		0.01	0.1	μA	
V_D	Diode forward voltage	$I_{IO} = 8 \text{ mA}$	Lower clamp diode		0.6	0.8	0.95	V
R_{DYN}	Dynamic resistance	$I = 1 \text{ A}$	Any IO pin		1.1		Ω	
C_{IO}	IO capacitance	$V_{CC} = 5 \text{ V}, V_{IO} = 2.5 \text{ V}$	Any IO pin		0.8		pF	
I_{CC}	Operating supply current	$V_{IO} = \text{Open}, V_{CC} = 5 \text{ V}$	V_{CC} pin		0.1	1	μA	

TYPICAL CHARACTERISTICS

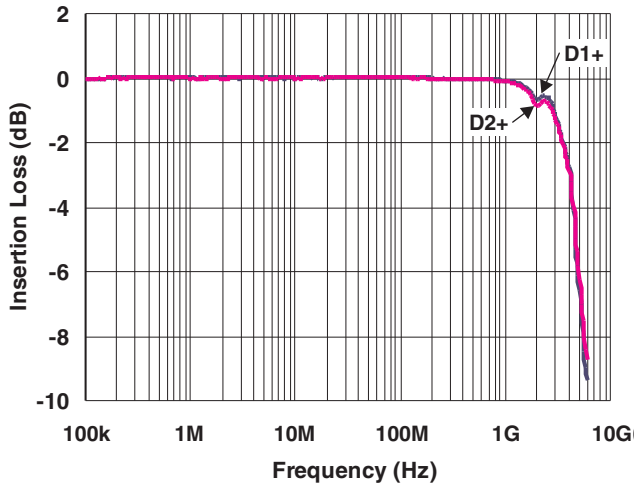

Figure 1. Insertion Loss S21 – I/O to GND

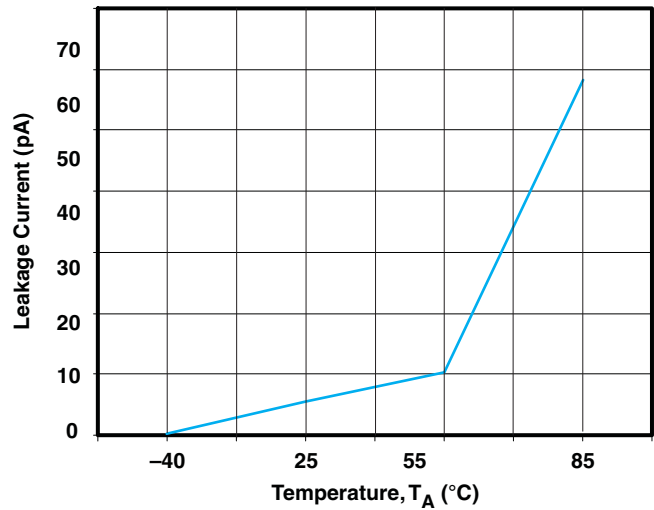

Figure 2. Leakage Current vs Temperature ($V_{IO} = 2.5\text{ V}$)

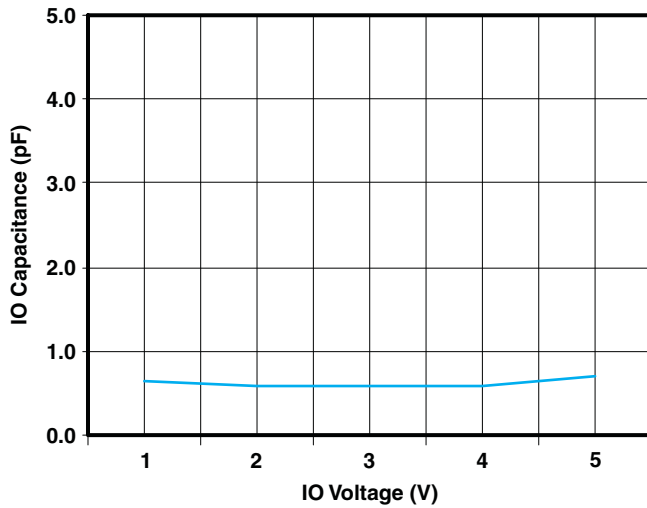

Figure 3. IO Capacitance vs Input Voltage ($V_{CC} = 5\text{ V}$)

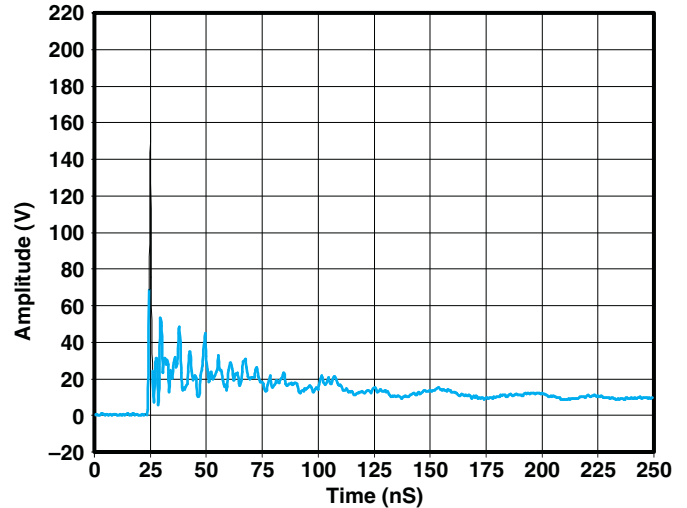

Figure 4. IEC Clamping Waveforms
(8-kV Contact, Average of Ten Waveforms)

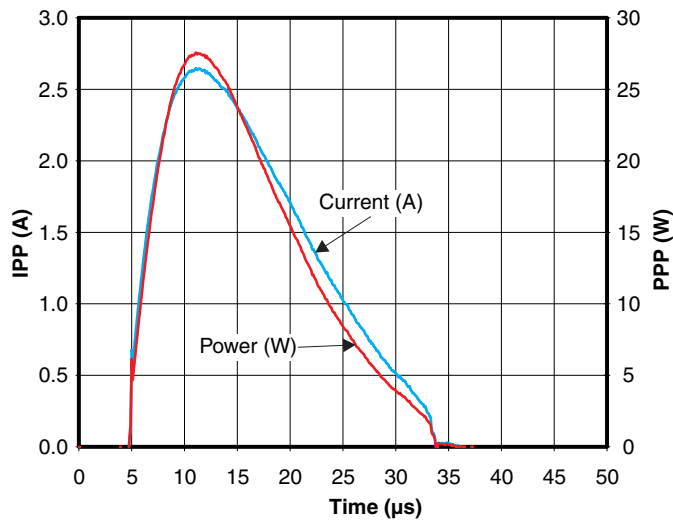

Figure 5. Pulse Waveform (8/20 μs Pulse)

TYPICAL CHARACTERISTICS (continued)

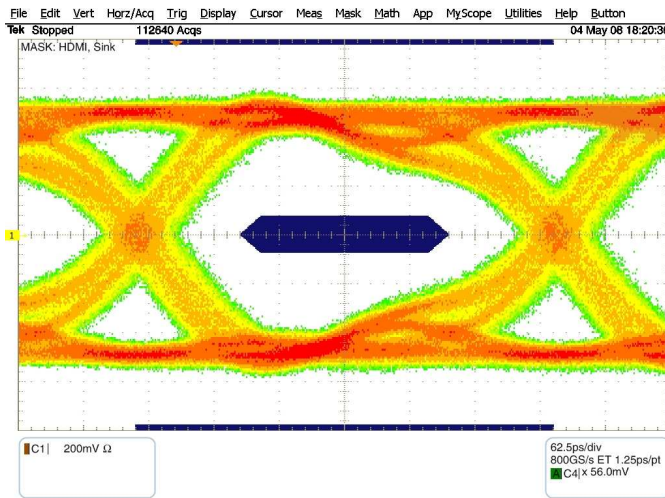

Figure 6. Eye Diagram Without TPD4S009

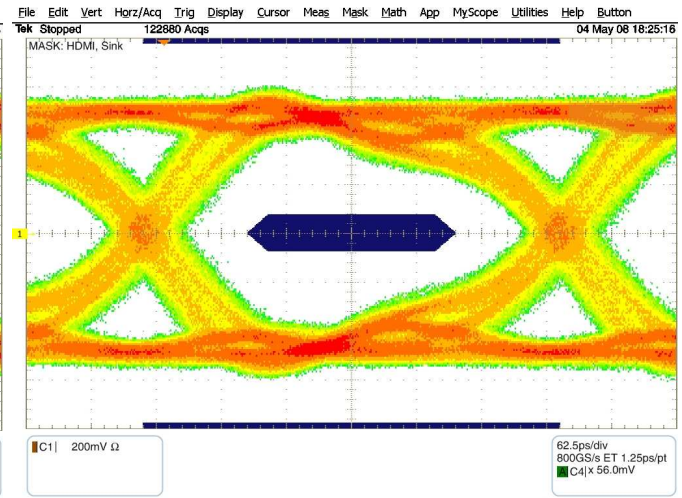

Figure 7. Eye Diagram With TPD4S009

PACKAGING INFORMATION

Orderable Device	Status ⁽¹⁾	Package Type	Package Drawing	Pins	Package Qty	Eco Plan ⁽²⁾	Lead/Ball Finish	MSL Peak Temp ⁽³⁾
TPD4S009DBVR	ACTIVE	SOT-23	DBV	6	3000	Green (RoHS & no Sb/Br)	CU NIPDAU	Level-1-260C-UNLIM
TPD4S009DBVRG4	ACTIVE	SOT-23	DBV	6	3000	Green (RoHS & no Sb/Br)	CU NIPDAU	Level-1-260C-UNLIM
TPD4S009DCKR	ACTIVE	SC70	DCK	6	3000	Green (RoHS & no Sb/Br)	CU NIPDAU	Level-1-260C-UNLIM
TPD4S009DCKRG4	ACTIVE	SC70	DCK	6	3000	Green (RoHS & no Sb/Br)	CU NIPDAU	Level-1-260C-UNLIM
TPD4S009DRYR	ACTIVE	SON	DRY	6	5000	Green (RoHS & no Sb/Br)	CU NIPDAU	Level-1-260C-UNLIM
TPD4S010DQAR	PREVIEW	SON	DQA	10	3000	TBD	Call TI	Call TI

⁽¹⁾ The marketing status values are defined as follows:

ACTIVE: Product device recommended for new designs.

LIFEBUY: TI has announced that the device will be discontinued, and a lifetime-buy period is in effect.

NRND: Not recommended for new designs. Device is in production to support existing customers, but TI does not recommend using this part in a new design.

PREVIEW: Device has been announced but is not in production. Samples may or may not be available.

OBSOLETE: TI has discontinued the production of the device.

⁽²⁾ Eco Plan - The planned eco-friendly classification: Pb-Free (RoHS), Pb-Free (RoHS Exempt), or Green (RoHS & no Sb/Br) - please check <http://www.ti.com/productcontent> for the latest availability information and additional product content details.

TBD: The Pb-Free/Green conversion plan has not been defined.

Pb-Free (RoHS): TI's terms "Lead-Free" or "Pb-Free" mean semiconductor products that are compatible with the current RoHS requirements for all 6 substances, including the requirement that lead not exceed 0.1% by weight in homogeneous materials. Where designed to be soldered at high temperatures, TI Pb-Free products are suitable for use in specified lead-free processes.

Pb-Free (RoHS Exempt): This component has a RoHS exemption for either 1) lead-based flip-chip solder bumps used between the die and package, or 2) lead-based die adhesive used between the die and leadframe. The component is otherwise considered Pb-Free (RoHS compatible) as defined above.

Green (RoHS & no Sb/Br): TI defines "Green" to mean Pb-Free (RoHS compatible), and free of Bromine (Br) and Antimony (Sb) based flame retardants (Br or Sb do not exceed 0.1% by weight in homogeneous material)

⁽³⁾ MSL, Peak Temp. -- The Moisture Sensitivity Level rating according to the JEDEC industry standard classifications, and peak solder temperature.

Important Information and Disclaimer:The information provided on this page represents TI's knowledge and belief as of the date that it is provided. TI bases its knowledge and belief on information provided by third parties, and makes no representation or warranty as to the accuracy of such information. Efforts are underway to better integrate information from third parties. TI has taken and continues to take reasonable steps to provide representative and accurate information but may not have conducted destructive testing or chemical analysis on incoming materials and chemicals. TI and TI suppliers consider certain information to be proprietary, and thus CAS numbers and other limited information may not be available for release.

In no event shall TI's liability arising out of such information exceed the total purchase price of the TI part(s) at issue in this document sold by TI to Customer on an annual basis.

TAPE AND REEL INFORMATION



QUADRANT ASSIGNMENTS FOR PIN 1 ORIENTATION IN TAPE



*All dimensions are nominal

Device	Package Type	Package Drawing	Pins	SPQ	Reel Diameter (mm)	Reel Width W1 (mm)	A0 (mm)	B0 (mm)	K0 (mm)	P1 (mm)	W (mm)	Pin1 Quadrant
TPD4S009DBVR	SOT-23	DBV	6	3000	180.0	9.2	3.23	3.17	1.37	4.0	8.0	Q3
TPD4S009DCKR	SC70	DCK	6	3000	180.0	9.2	2.55	2.34	1.22	4.0	8.0	Q3
TPD4S009DRYR	SON	DRY	6	5000	179.0	8.4	1.2	1.65	0.7	4.0	8.0	Q1

TAPE AND REEL BOX DIMENSIONS



*All dimensions are nominal

Device	Package Type	Package Drawing	Pins	SPQ	Length (mm)	Width (mm)	Height (mm)
TPD4S009DBVR	SOT-23	DBV	6	3000	205.0	200.0	33.0
TPD4S009DCKR	SC70	DCK	6	3000	202.0	201.0	28.0
TPD4S009DRYR	SON	DRY	6	5000	220.0	205.0	50.0

DBV (R-PDSO-G6)

PLASTIC SMALL-OUTLINE PACKAGE

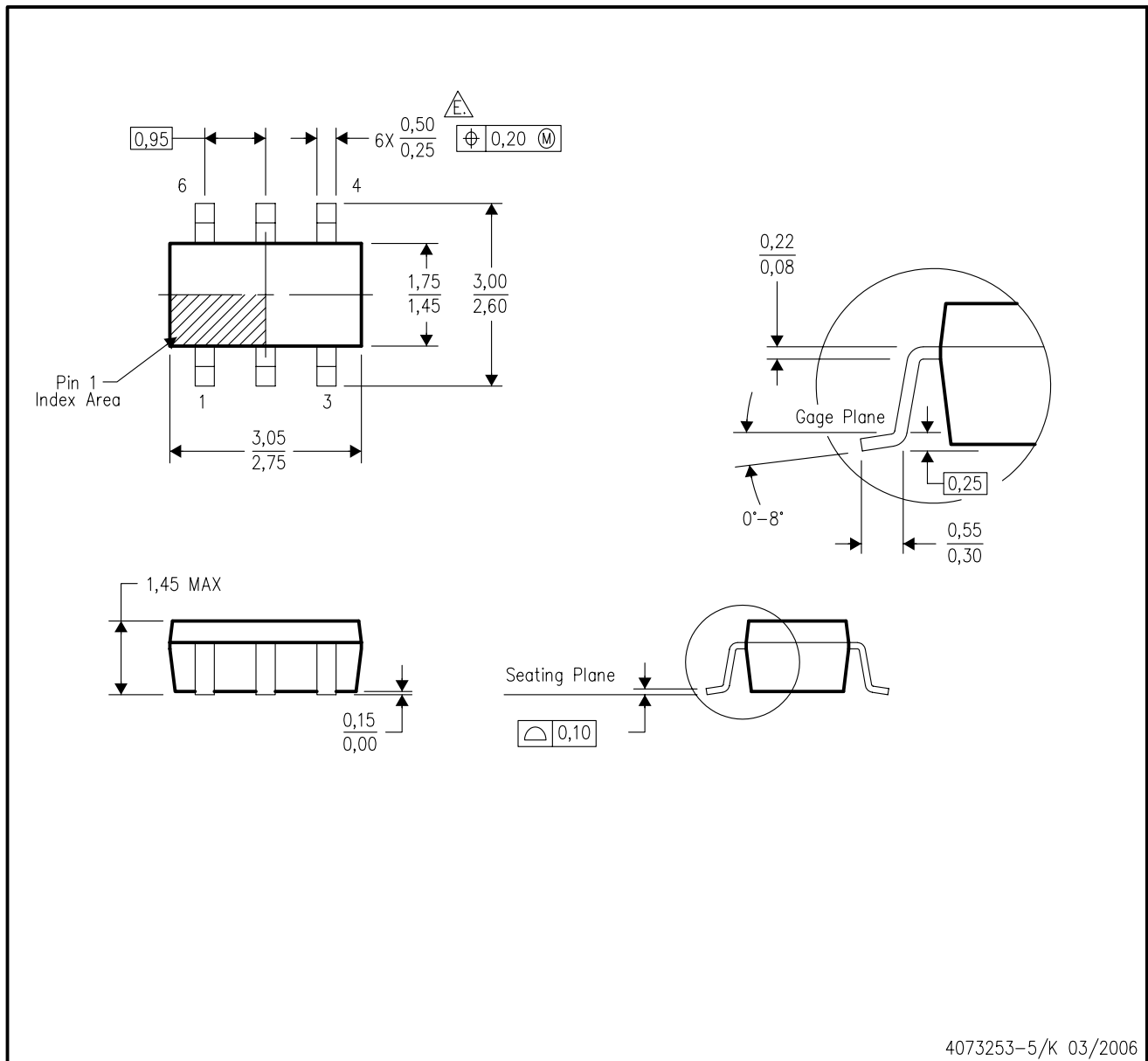

- NOTES:
- A. All linear dimensions are in millimeters.
 - B. This drawing is subject to change without notice.
 - C. Body dimensions do not include mold flash or protrusion. Mold flash and protrusion shall not exceed 0.15 per side.
 - D. Leads 1,2,3 may be wider than leads 4,5,6 for package orientation.
 - $\triangle E$. Falls within JEDEC MO-178 Variation AB, except minimum lead width.

DRY (R-PDSO-N6)

PLASTIC SMALL OUTLINE

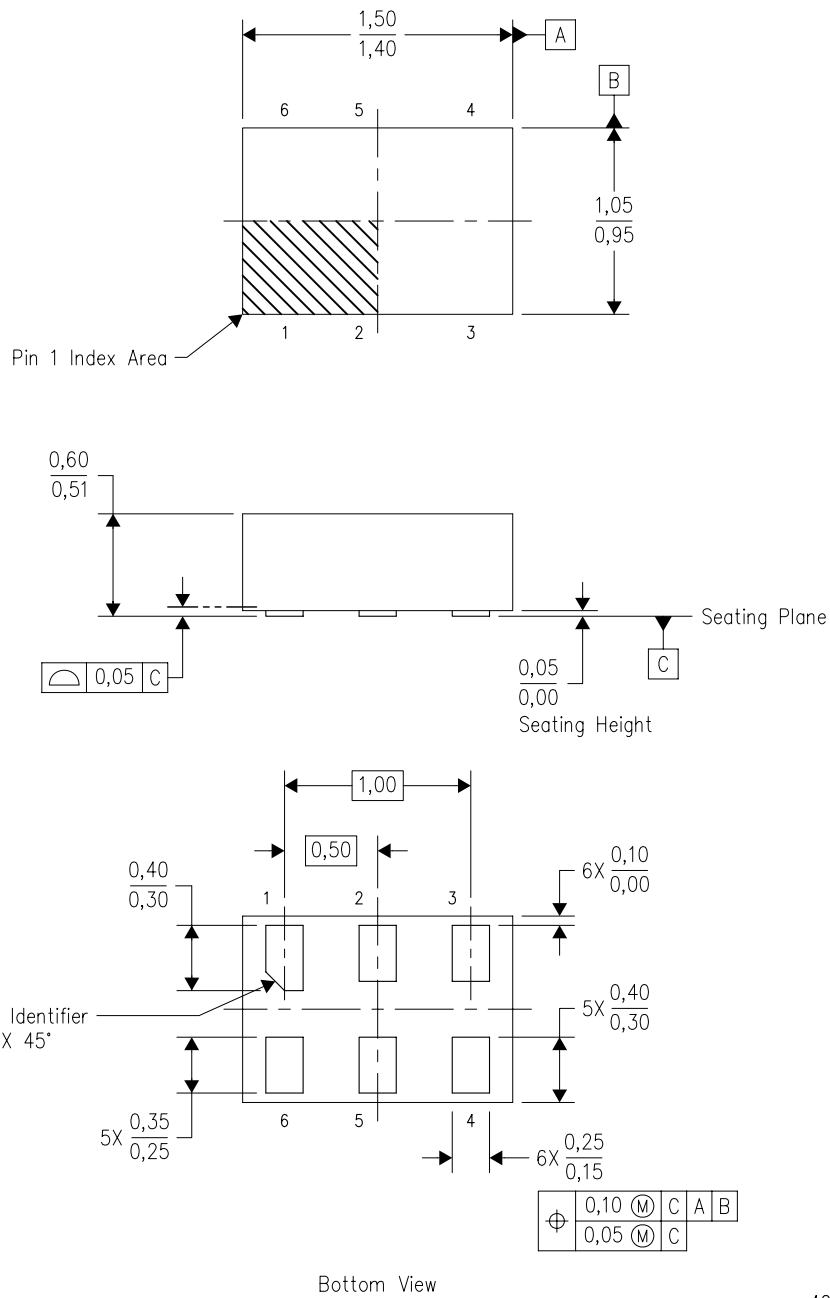

4207181/B 12/2007

- NOTES:
- A. All linear dimensions are in millimeters. Dimensioning and tolerancing per ASME Y14.5M-1994.
 - B. This drawing is subject to change without notice.
 - C. SON (Small Outline No-Lead) package configuration.
 - D. This package complies to JEDEC MO-287 variation UFAD.

IMPORTANT NOTICE

Texas Instruments Incorporated and its subsidiaries (TI) reserve the right to make corrections, modifications, enhancements, improvements, and other changes to its products and services at any time and to discontinue any product or service without notice. Customers should obtain the latest relevant information before placing orders and should verify that such information is current and complete. All products are sold subject to TI's terms and conditions of sale supplied at the time of order acknowledgment.

TI warrants performance of its hardware products to the specifications applicable at the time of sale in accordance with TI's standard warranty. Testing and other quality control techniques are used to the extent TI deems necessary to support this warranty. Except where mandated by government requirements, testing of all parameters of each product is not necessarily performed.

TI assumes no liability for applications assistance or customer product design. Customers are responsible for their products and applications using TI components. To minimize the risks associated with customer products and applications, customers should provide adequate design and operating safeguards.

TI does not warrant or represent that any license, either express or implied, is granted under any TI patent right, copyright, mask work right, or other TI intellectual property right relating to any combination, machine, or process in which TI products or services are used. Information published by TI regarding third-party products or services does not constitute a license from TI to use such products or services or a warranty or endorsement thereof. Use of such information may require a license from a third party under the patents or other intellectual property of the third party, or a license from TI under the patents or other intellectual property of TI.

Reproduction of TI information in TI data books or data sheets is permissible only if reproduction is without alteration and is accompanied by all associated warranties, conditions, limitations, and notices. Reproduction of this information with alteration is an unfair and deceptive business practice. TI is not responsible or liable for such altered documentation. Information of third parties may be subject to additional restrictions.

Resale of TI products or services with statements different from or beyond the parameters stated by TI for that product or service voids all express and any implied warranties for the associated TI product or service and is an unfair and deceptive business practice. TI is not responsible or liable for any such statements.

TI products are not authorized for use in safety-critical applications (such as life support) where a failure of the TI product would reasonably be expected to cause severe personal injury or death, unless officers of the parties have executed an agreement specifically governing such use. Buyers represent that they have all necessary expertise in the safety and regulatory ramifications of their applications, and acknowledge and agree that they are solely responsible for all legal, regulatory and safety-related requirements concerning their products and any use of TI products in such safety-critical applications, notwithstanding any applications-related information or support that may be provided by TI. Further, Buyers must fully indemnify TI and its representatives against any damages arising out of the use of TI products in such safety-critical applications.

TI products are neither designed nor intended for use in military/aerospace applications or environments unless the TI products are specifically designated by TI as military-grade or "enhanced plastic." Only products designated by TI as military-grade meet military specifications. Buyers acknowledge and agree that any such use of TI products which TI has not designated as military-grade is solely at the Buyer's risk, and that they are solely responsible for compliance with all legal and regulatory requirements in connection with such use.

TI products are neither designed nor intended for use in automotive applications or environments unless the specific TI products are designated by TI as compliant with ISO/TS 16949 requirements. Buyers acknowledge and agree that, if they use any non-designated products in automotive applications, TI will not be responsible for any failure to meet such requirements.

Following are URLs where you can obtain information on other Texas Instruments products and application solutions:

Products

Amplifiers	amplifier.ti.com
Data Converters	dataconverter.ti.com
DSP	dsp.ti.com
Clocks and Timers	www.ti.com/clocks
Interface	interface.ti.com
Logic	logic.ti.com
Power Mgmt	power.ti.com
Microcontrollers	microcontroller.ti.com
RFID	www.ti-rfid.com
RF/IF and ZigBee® Solutions	www.ti.com/lprf

Applications

Audio	www.ti.com/audio
Automotive	www.ti.com/automotive
Broadband	www.ti.com/broadband
Digital Control	www.ti.com/digitalcontrol
Medical	www.ti.com/medical
Military	www.ti.com/military
Optical Networking	www.ti.com/opticalnetwork
Security	www.ti.com/security
Telephony	www.ti.com/telephony
Video & Imaging	www.ti.com/video
Wireless	www.ti.com/wireless

Mailing Address: Texas Instruments, Post Office Box 655303, Dallas, Texas 75265
Copyright © 2008, Texas Instruments Incorporated